

LOCKIN

QUICK START GUIDE

Veno Solar Series Smart Lock

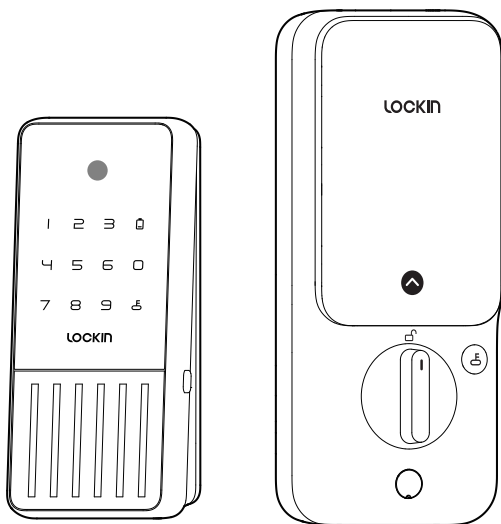

PN: 0524222001

Model: LKMSD650
Model: LKMSD650A

Overview of Product Feature & Layout

Exterior Assembly

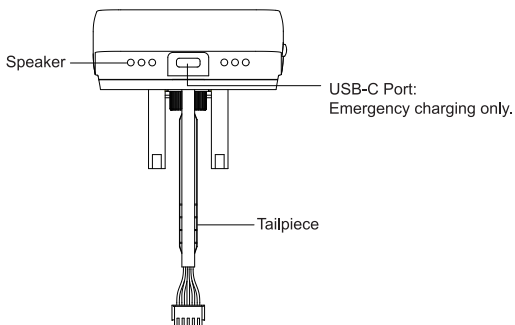
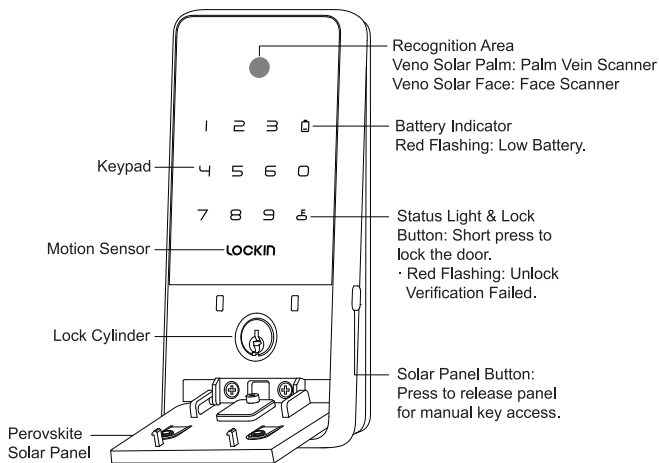

Interior Assembly

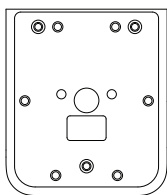
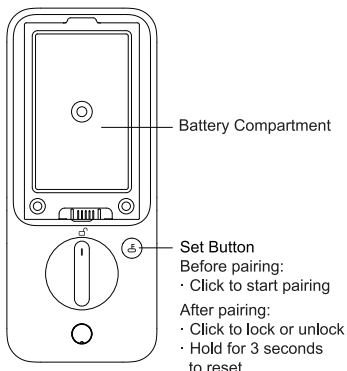
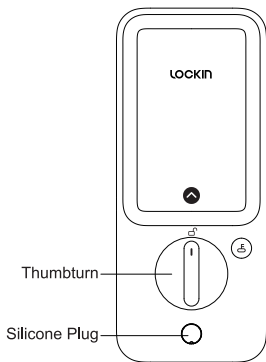

Mounting Plate

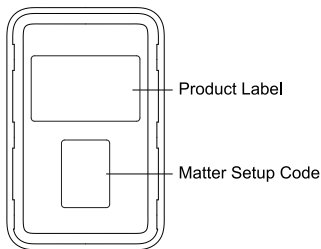

Battery Cover



Quick Start Guide

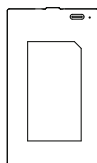

Rechargeable
Lithium-ion Battery

Parts List

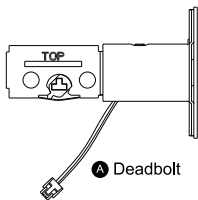

A Deadbolt



B Deadbolt&Strike Plate Screw (#7 1") x 5

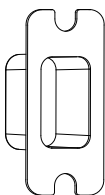

C Strike Box

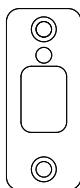

D Strike Plate



E Backup Key x 2



F Mounting Plate Screws (#8-32 TPI x 1½) x 2



G Interior Assembly Screws (M4*8) x 3



H Door Sensor Magnet x 1

Installation Preparation

This guide will help you get things set up. In the app, you can also follow these steps and watch the video tutorial.

For an easier installation, we recommend having a helping hand nearby.

• CHARGING THE BATTERY BEFORE INSTALLATION

Fully charge the rechargeable battery before using it for the first time. This can take up to 6-8 hours.

Use a 5V/2A adapter for best charging performance. USB-C input: 5V/2A.

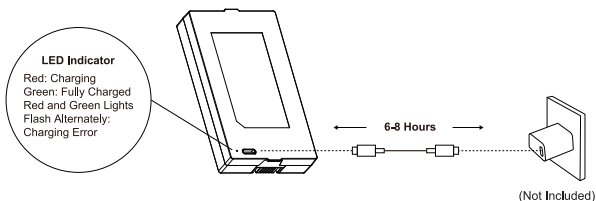

• Required Tools (Not Included)

💡 Don't use a power screwdriver. It may damage your lock.

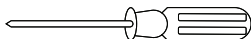

#2 Phillips Screwdriver

INSTALLATION GUIDE

Installation generally takes less than 30 minutes. If you have any questions or concerns, email to support@lockin.com for assistance.

✉ support@lockin.com

How to Open the Solar Panel

Step 1: Press the solar panel button on the side of the exterior assembly to release the panel.



Step 2: Lift the panel upward, then gently pull it outward to open it completely.

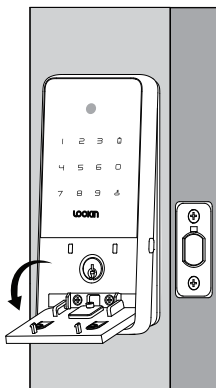

Note: Do not pull the solar panel with excessive force to avoid damage.

1 Prepare the Door for Installation

1. Remove the existing lock and check your door.
2. Check if your door has holes as illustrated below. If not, use the template and drill holes in your door.

Door Thickness: $1\frac{3}{8}$ in - $2\frac{11}{64}$ in / 35-55mm

Crossbore Diameter: $1\frac{1}{2}$ in / 38 mm, $2\frac{1}{8}$ in / 54 mm

Backset: $2\frac{3}{8}$ in / 60 mm or $2\frac{3}{4}$ in / 70 mm

Door Hole Diameter: 1 in / 25.4 mm

Minimum Distance: 2 in / 50 mm

Crossbore center to door stop: $> 1\frac{9}{16}$ in / 40mm

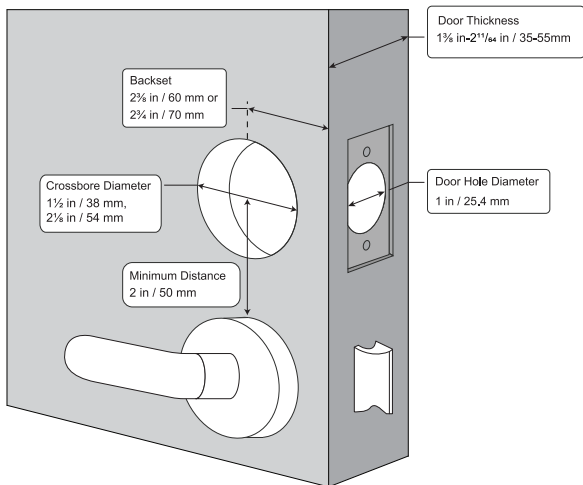

Need help?

Please contact support@lockin.com

➤ Install the Deadbolt

1. Determine if the latch needs to be adjusted.

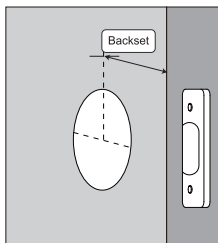

If the backset is $2\frac{3}{8}$ in / 60 mm, insert the deadbolt directly.

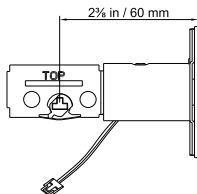

If the backset is 70 mm, rotate the faceplate of the deadbolt 180° to adjust the length.

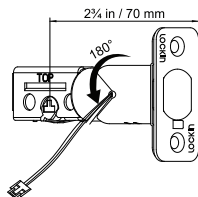

To adjust, twist the latch until it stops.

Reverse the direction to return to the $2\frac{3}{8}$ in (60 mm) backset.

2. Insert and screw the deadbolt into the door. Make sure the word "TOP" on the deadbolt faces up, and the T-shaped hub of the deadbolt is centered.

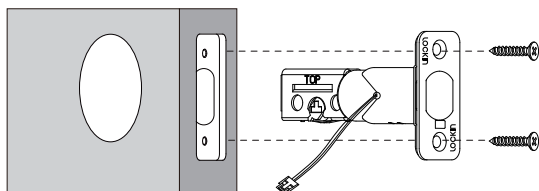
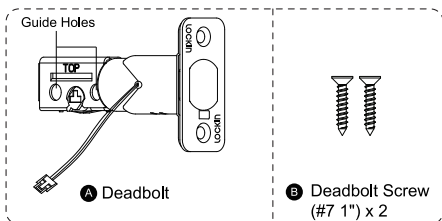

3 Install Exterior Assembly

Check if the crossbore diameter is $1\frac{1}{2}$ in / 38 mm or $2\frac{1}{8}$ in / 54 mm.

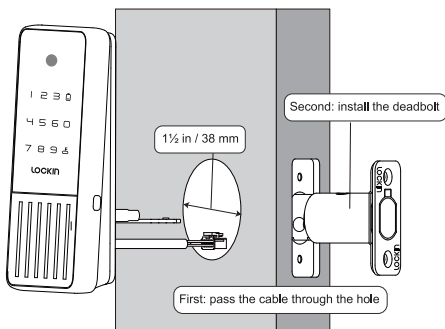

For a $1\frac{1}{2}$ in (38mm) crossbore hole: First, feed the cable of exterior assembly through the hole.

Have a helper assist you with the installation.

For a 2 1/8 in (54 mm) crossbore hole: You can install the deadbolt directly first.

1. Insert the deadbolt into the edge bore on the side of the door.
2. Route the cable through the gap below the deadbolt.
3. Ensure "TOP" faces up and the T-slot is centered.

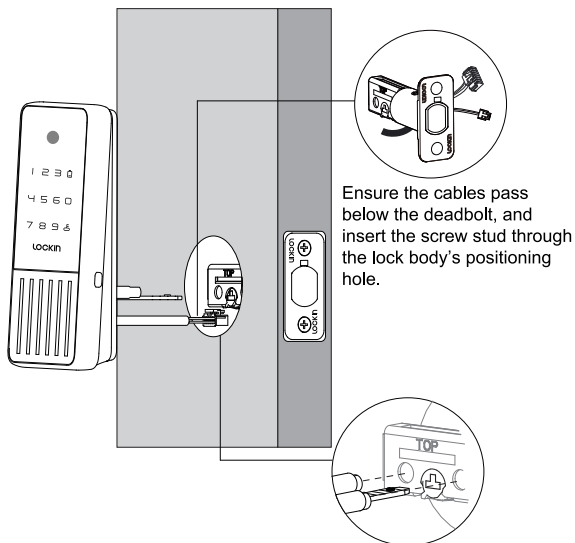

Need help?

Please contact support@lockin.com

4 Install the Mounting Plate

1. Detach the mounting plate and battery cover from the interior assembly.

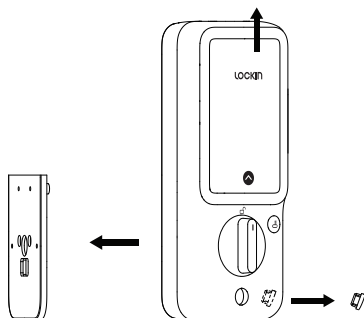

2. Run the cables through the slot on the mounting plate. Make sure the silicone pad is against the door.

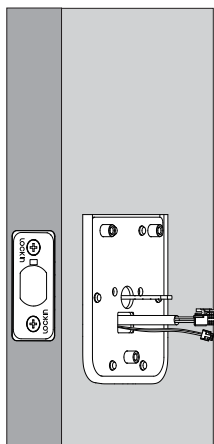

3. Align the mounting plate with the threaded screw receptacles of the exterior assembly.



F Mounting Plate Screws
(#8-32 TPI x 1½) x 2

IMPORTANT: Before inserting and tightening screws, we recommend following the steps below. Ensure that the correct screws are used (refer to the diagram for details), because using the wrong ones may cause an installation failure or lock damage.

Tightly fasten the screws in place. Hand-tighten the screws first, then use a screwdriver to secure them.

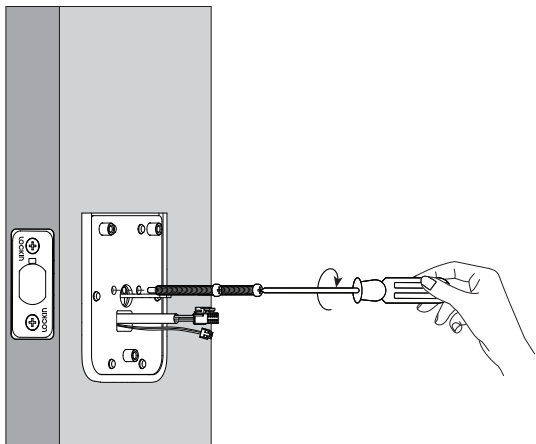

5 Install Interior Assembly

1. Plug the cables into the sockets on the back of the interior assembly.

Route the cables around the tailpiece receiver to avoid pinching during installation.

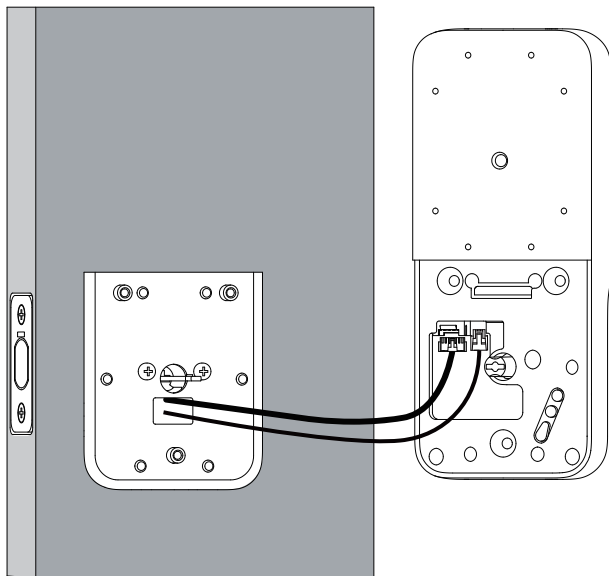

 **IMPORTANT!** Make sure the cables are properly plugged in.

Need help?

Please contact support@lockin.com

2. Insert the T-shaped tailpiece of the exterior keypad into the T-shaped tailpiece receiver of the interior assembly. Make sure the deadbolt is retracted and the thumbturn knob is in the 'unlock' position.

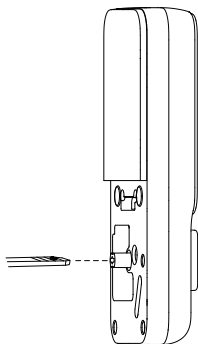
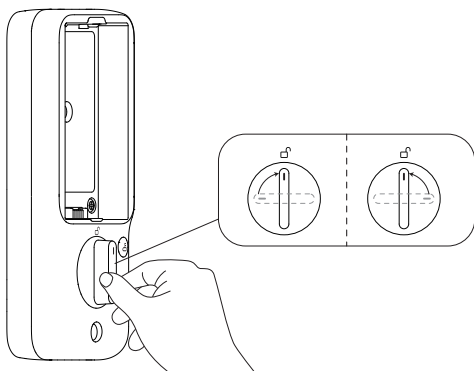

Arrange the cables to avoid pinching them when inserting the tailpiece into the interior assembly.

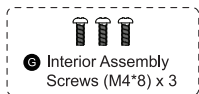

Use a long screwdriver to fasten the interior assembly screws. Attach the interior assembly closely to the door panel and tighten it with interior assembly screws, then ensure to install the silicone plug.

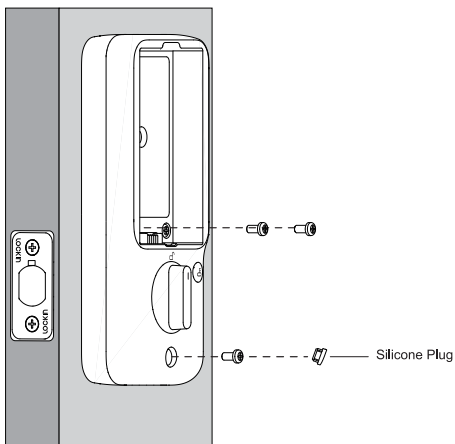

3. Check if the latch extends and retracts smoothly by rotating the thumbturn, with no sticking or jamming.

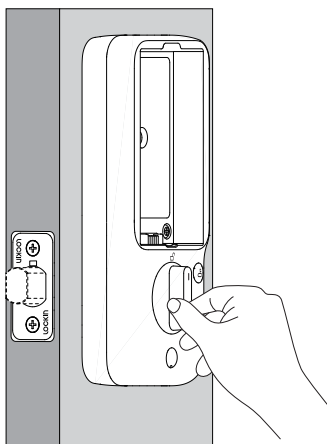

4. If a slight gap exists between the interior assembly and the door, use additional screws for fastening.

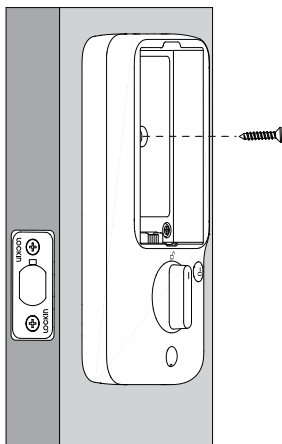

5. Insert the rechargeable battery into the battery compartment, close the battery cover, and check if the device powers on properly.

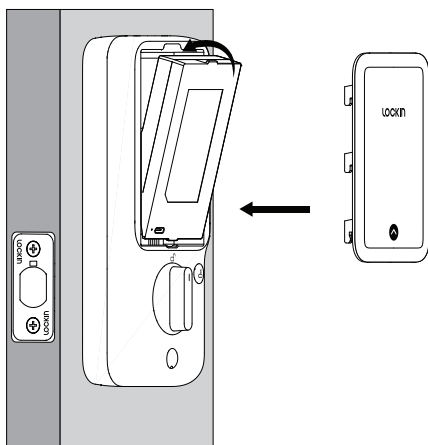

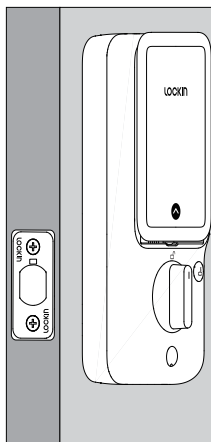

6 Install Strike Plate

The strike hole must be at least 1 in (25.4 mm) deep. Otherwise, calibration may fail during setup, and the lock may not work properly.

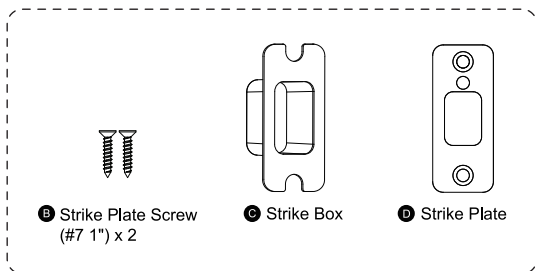

Install strike plate and dust box.

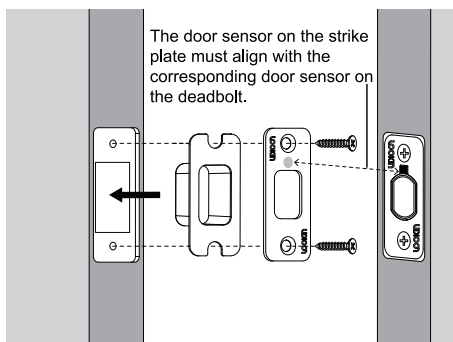
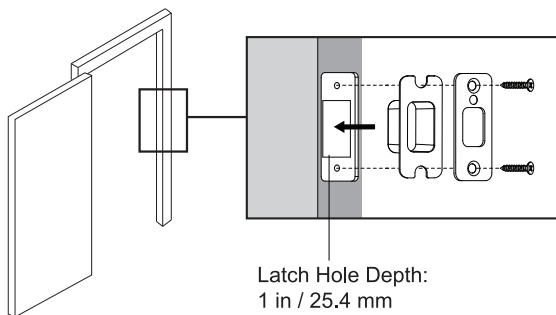

➤ Want to use your original strike plate

We've included a spare magnet. Follow these steps for setup:

Step 1: Select position based on backset (latch length):

60mm backset: Stick above the strike plate.

70mm backset: Stick below the strike plate.

Step 2: Wipe the area with a dry cloth or alcohol pad; ensure it is dust and oil-free.

Step 3:

Align: Peel off the backing and align the sensor.

Press: Press firmly for 30 seconds with the door open

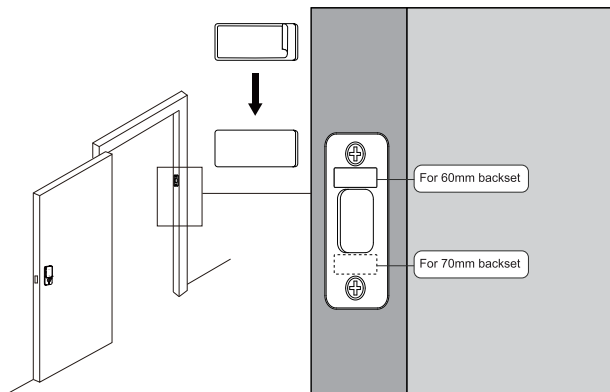

SETTING UP

1 Download the Lockin Smart app and sign in or create an account

1. Scan the QR code below to download.



2. Search for "Lockin Smart" on the Apple App Store or Google Play Store.



Apple logo and App Store are trademarks of Apple Inc., registered in the U.S. and other countries and regions.



Google Assistant, Google Home, Google Play, and the Google Play logo are trademarks of Google LLC.

- 2** In the Lockin Smart app, tap the + plus sign, then Add Device > Home > Veno Solar Palm \ Veno Solar Face. Follow the in-app installation and setup instructions to complete setup.

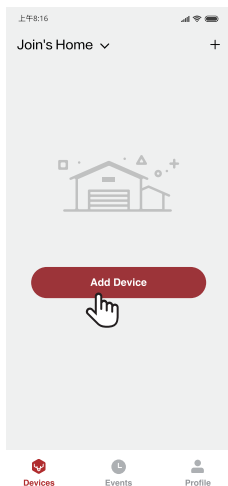

- 3** Once setup is complete, install the battery cover. Veno Solar Palm \ Veno Solar Face is now ready to use.

FCC compliance statement

This device complies with Part 15 of the FCC Rules. Operation is subject to the following two conditions: (1) this device may not cause harmful interference, and (2) this device must accept any interference received, including interference that may cause undesired operation.

changes or modifications not expressly approved by the party responsible for compliance could void the user's authority to operate the equipment.

This equipment has been tested and found to comply with the limits for a Class B digital device, pursuant to Part 15 of the FCC Rules. These limits are designed to provide reasonable protection against harmful interference in a residential installation. This equipment generates, uses and can radiate radio frequency energy and, if not installed and used in accordance with the instructions, may cause harmful interference to radio communications. However, there is no guarantee that interference will not occur in a particular installation.

If this equipment does cause harmful interference to radio or television reception, which can be determined by turning the equipment off and on, the user is encouraged to try to correct the interference by one or more of the following measures:

- Reorient or relocate the receiving antenna.
- Increase the separation between the equipment and receiver.
- Connect the equipment into an outlet on a circuit different from that to which the receiver is connected.
- Consult the dealer or an experienced radio/TV technician for help.

ISED compliance statement

This device contains licence-exempt transmitter(s)/receiver(s) that comply with Innovation, Science and Economic Development Canada's licence-exempt RSS(s). Operation is subject to the

following two conditions:

- (1) This device may not cause interference.
- (2) This device must accept any interference, including interference that may cause undesired operation of the device.

L'émetteur/récepteur exempt de licence contenu dans le présent appareil est conforme aux CNR d'Innovation, Sciences et Développement économique Canada applicables aux appareils radio exempts de licence.

L'exploitation est autorisée aux deux conditions suivantes :

- (1) L'appareil ne doit pas produire de brouillage;
- (2) L'appareil doit accepter tout brouillage radioélectrique subi, même si le brouillage est susceptible d'en compromettre le fonctionnement.

FCC Radiation Exposure statement

This equipment complies with FCC radiation exposure limits set forth for an uncontrolled environment. This equipment should be installed and operated with minimum distance 20cm between the radiator and your body. This transmitter must not be co-located or operating in conjunction with any other antenna or transmitter.

ISED Radiation Exposure statement

This equipment complies with IC RSS-102 radiation exposure limits set forth for an uncontrolled environment. This equipment should be installed and operated with minimum distance 20 cm between the radiator and your body.

Cet équipement est conforme aux limites d'exposition aux radiations IC RSS-102 établies pour un environnement non contrôlé. Cet équipement doit être installé et utilisé à une distance minimale de 20 cm entre le radiateur et votre corps.

For ICES

CAN ICES-003(B) / NMB-003(B)

Warning

- Replacement of a battery with an incorrect type that can defeat a safeguard
- Disposal of a battery into fire or a hot oven, or mechanically crushing or cutting of a battery. that can result in an explosion;
- Leaving a battery in an extremely high temperature surrounding environment that can result in an explosion or the leakage of flammable liquid or gas; and a battery subjected to extremely low air pressure that may result in an explosion or the leakage of flammable liquid or gas.



Scan to watch installation video

Specifications

Product Name	Veno Solar Palm Vein Recognition Smart Lock	Veno Solar Face Recognition Smart Lock
Recognition	Palm Vein	Face
Model	LKMSD650	LKMSD650A
FCC ID	2BMOG-LKMSD650	
IC	33374-LKMSD650	
HVIN	LKMSD650	LKMSD650A
Voltage	7.4V (Functional above 6.6V)	
IP Rating	IP53	
Connectivity	BLE 5.0 & 2.4 GHz WiFi & 24 GHz radar	

Customer Service and Warranty

12-month limited warranty

Contact us

www.lockin.com | support@lockin.com

LOCKIN (U.S.) INC.

8605 Santa Monica Blvd #79525 West Hollywood,
CA 90069-4109

LOCKIN (U.S.) INC. All rights reserved, registered in the United States and other countries.